

1

REV:00

DQ
WALL · SUPPORT

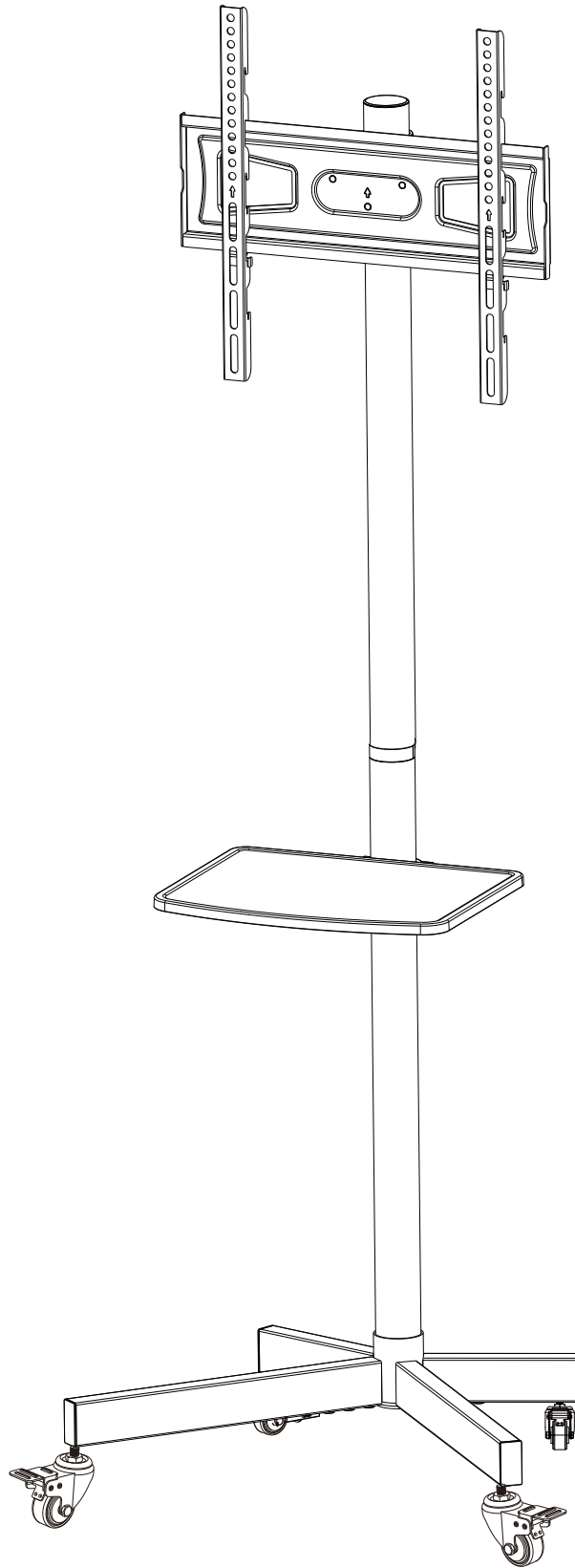

100x100 100x400
100x200 200x400
200x200 300x400
200x300 400x400
300x300











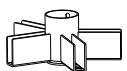



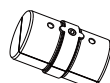

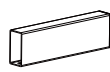
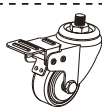

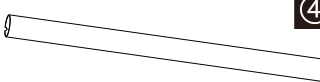
CAUTION: DO NOT EXCEED
RATED LISTED WEIGHT. SERIOUS
INJURY OR PROPERTY DAMAGE
MAY OCCUR!

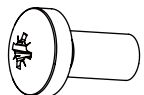
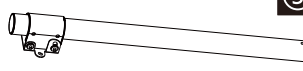
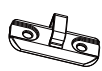

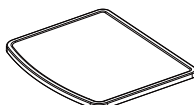
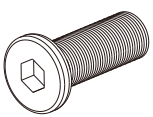

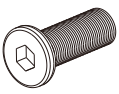
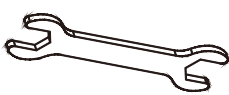

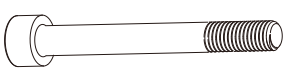
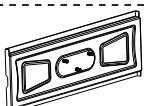



DQ17-1200

PART LIST



	1 X1		10 X1		M6*18*1.5 D X6
	2 X2		11 X1		M6 E X3
	3 X2		12 X2		F X2
	4 X1		13 X2		M5 G X2
	5 X1		14 X1		H X1 4mm
	6 X1		M8*16 A X12		I X1 5mm
	7 X1		M6*12 B X4		J X1 10*14
	8 X2		M5*55 C X2		
	9 X1				





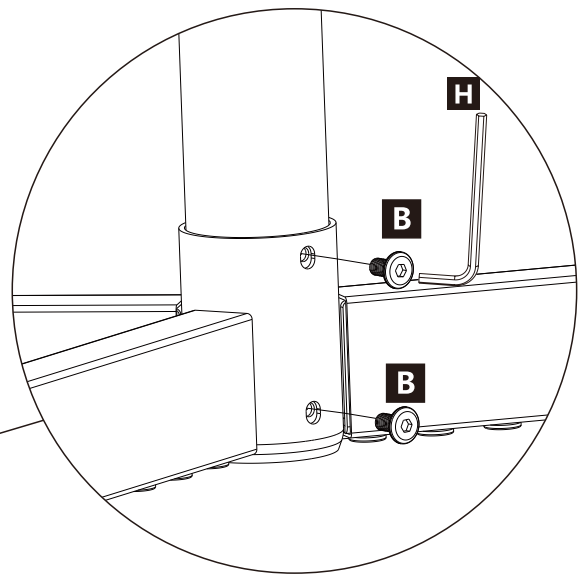
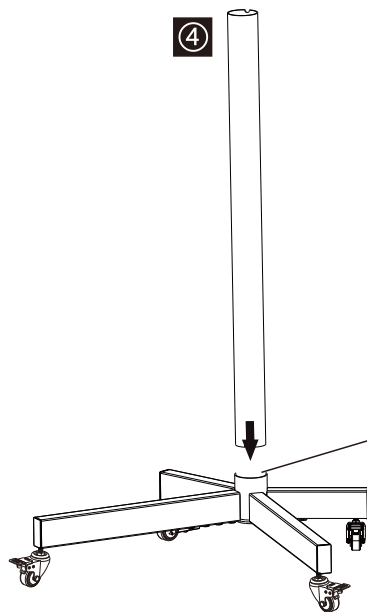
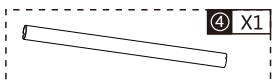
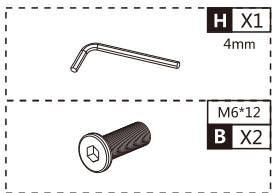
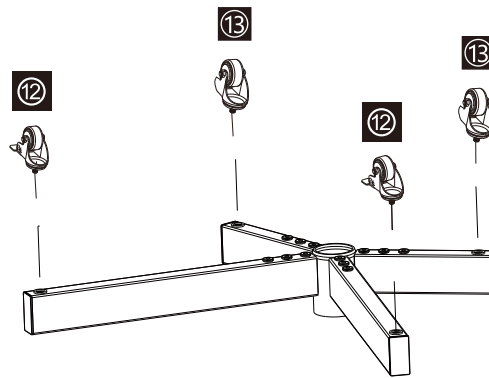
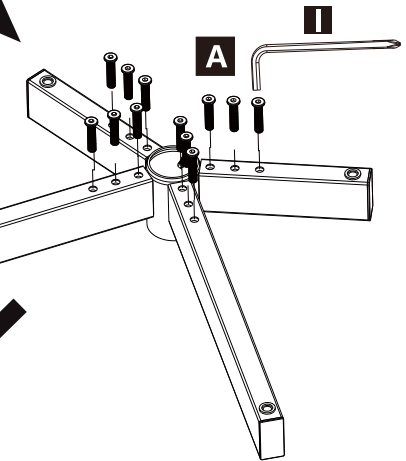
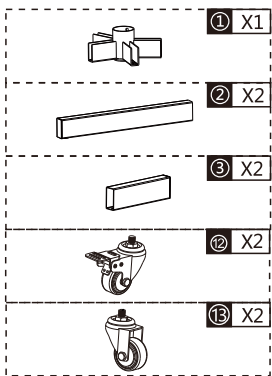
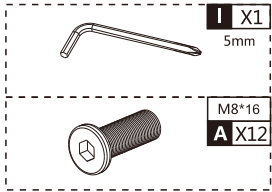
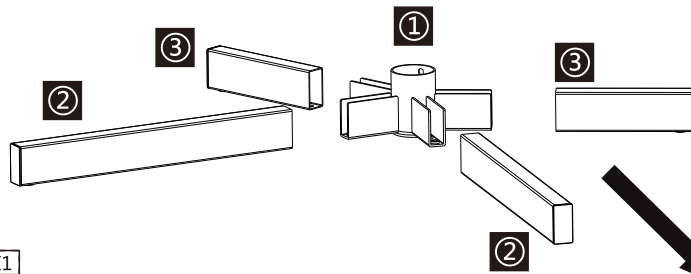

FOR TV INSTALLATION

					
M4X12 TV1 X4	M4X30 TV2 X4	M6X16 TV3 X4	M6X35 TV4 X4	M8X25 TV5 X4	M8X50 TV6 X4
					
Unterlegscheibe TV7 X4	SP1 TV8 X8	SP2 TV9 X8	SP3 TV10 X8		



3

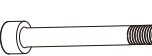

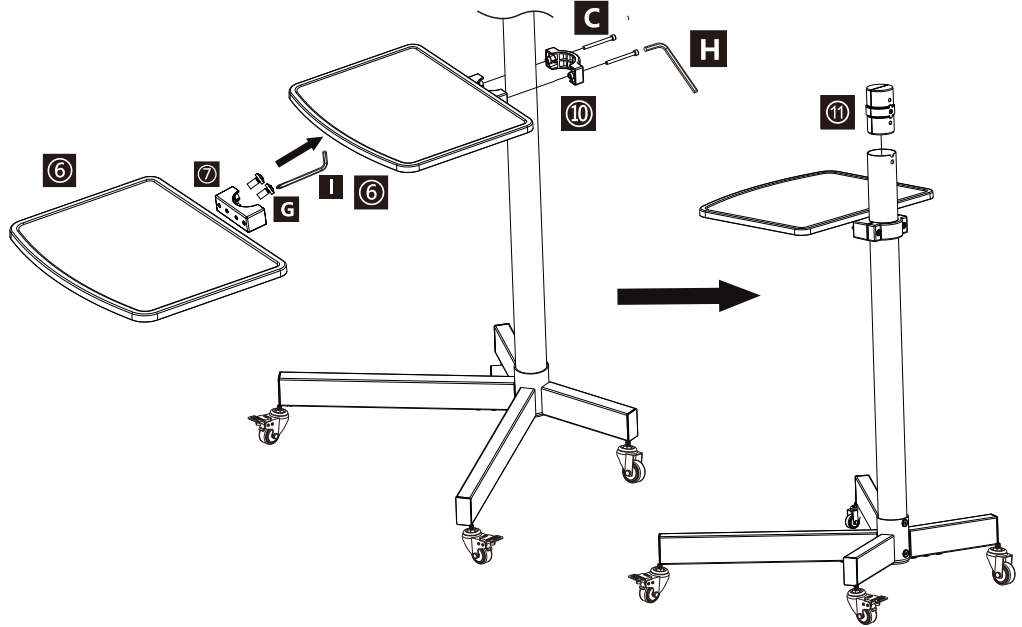

4

-  **6** X1
-  **10** X1
-  **11** X1
-  **7** X1
-  M5
G X2
-  M5*55
C X2
-  **I** X1
5mm
-  **H** X1
4mm



-  **5** X1
-  **13** X1

-  **H** X1
4mm
-  M6*12
B X2

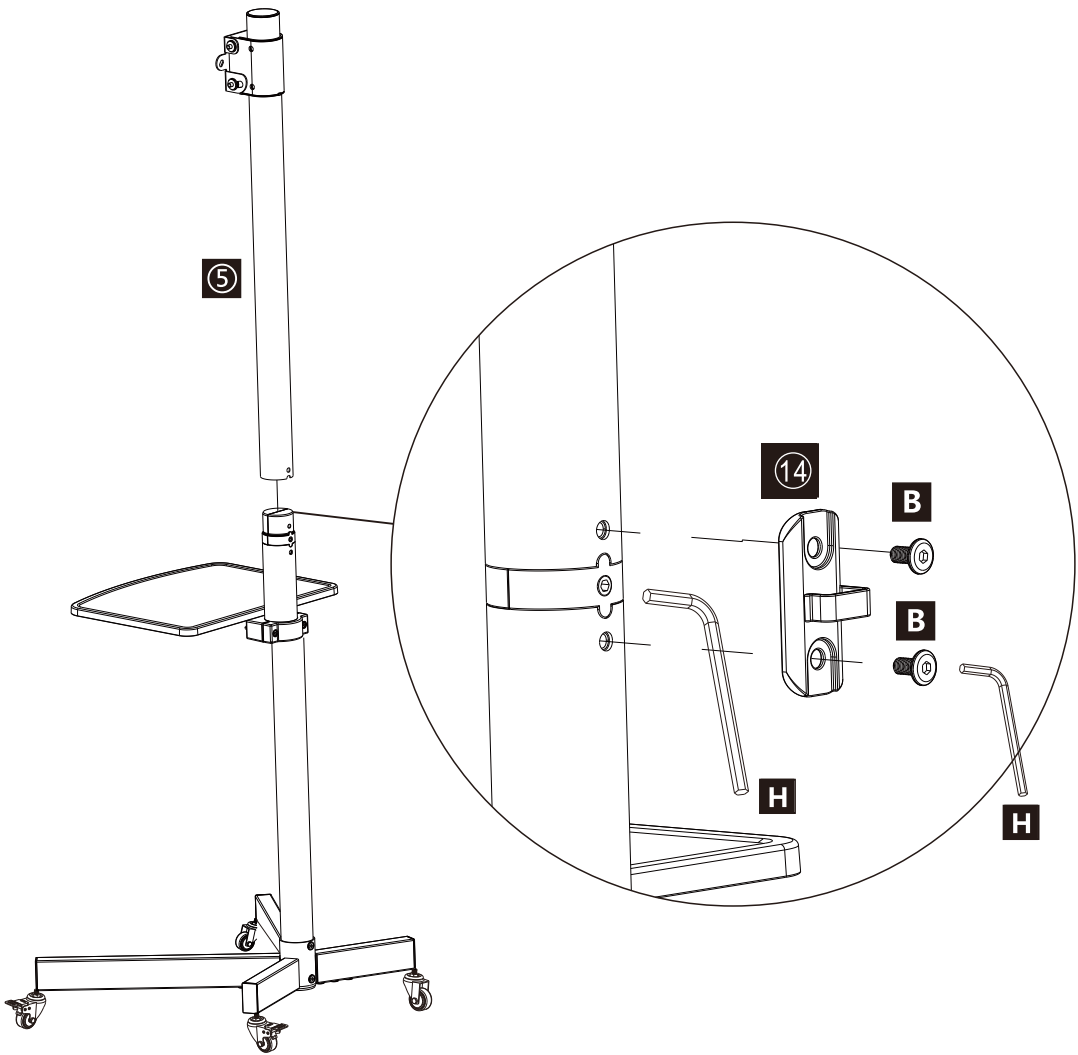

5

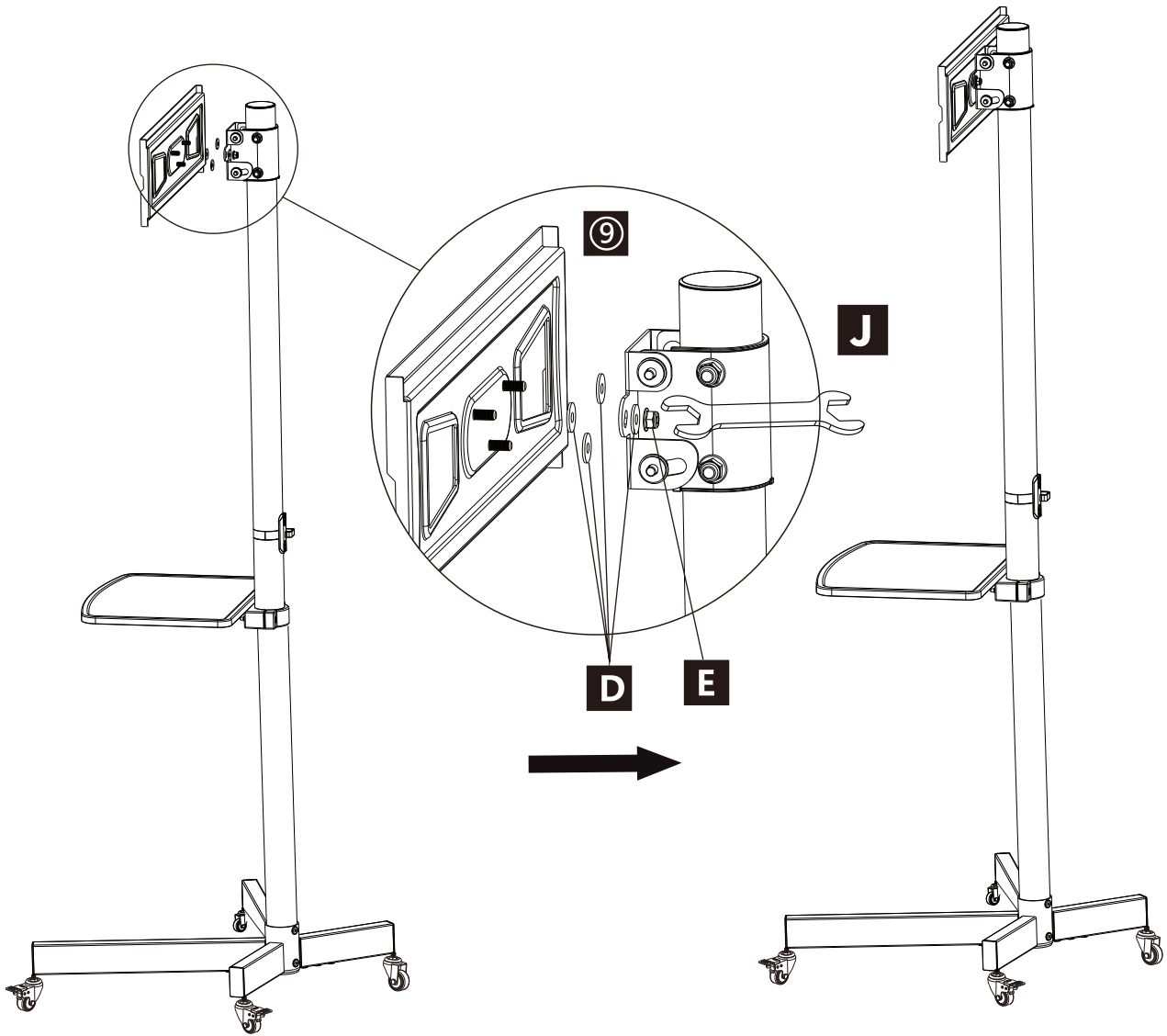
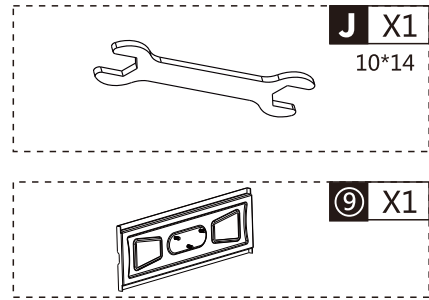
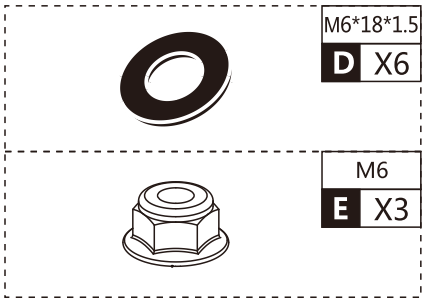

6

Measure the TV fixing holes Width and Height

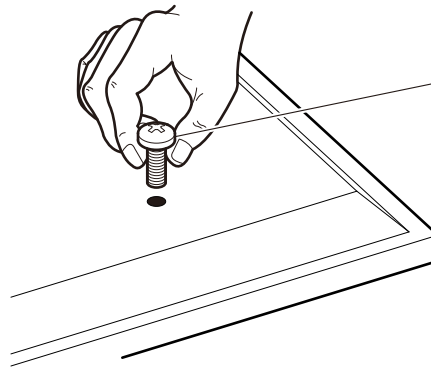
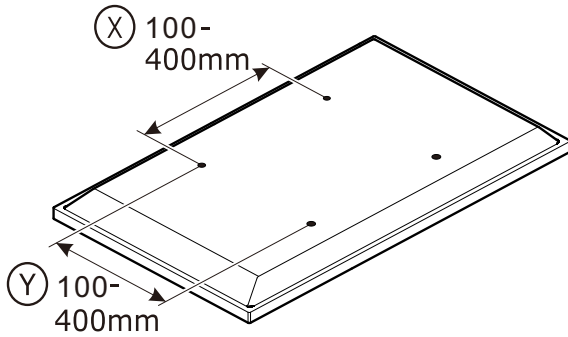

TV1-TV2

TV3-TV4

TV5-TV6



If width (X) is greater than 600mm or height (Y) greater than 400mm STOP installation now and contact the customer help line

You are provided with 4 diameters of TV fixing screws, **M4**, **M6** and **M8**. Determine the screw diameter that fits.

Spacers

SP

For TVs with irregular/obstructed back

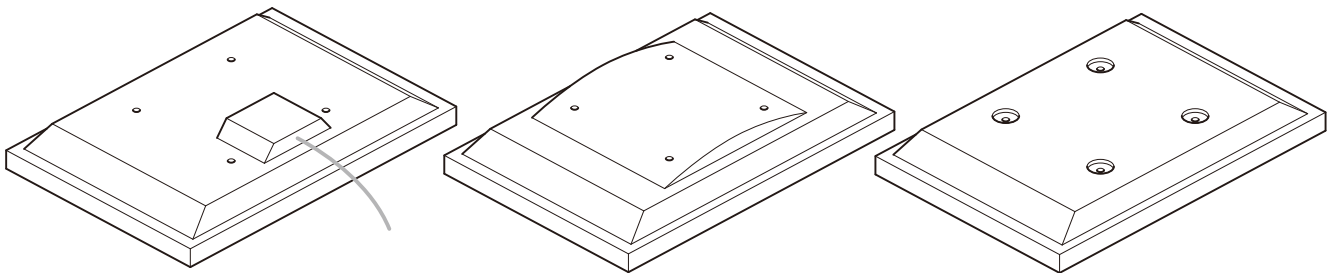

No Spacers

For TVs with flat/unobstructed back

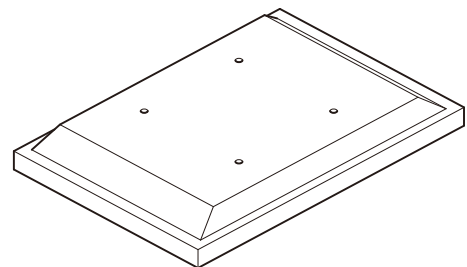

WARNING

please keep for future reference.

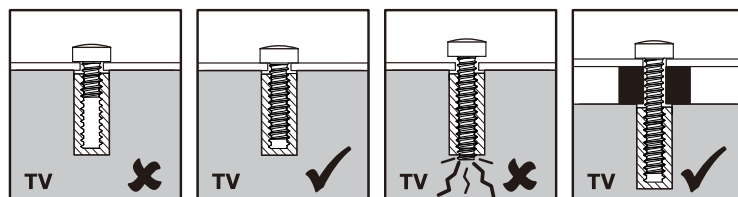

7

NOT INCLUDED

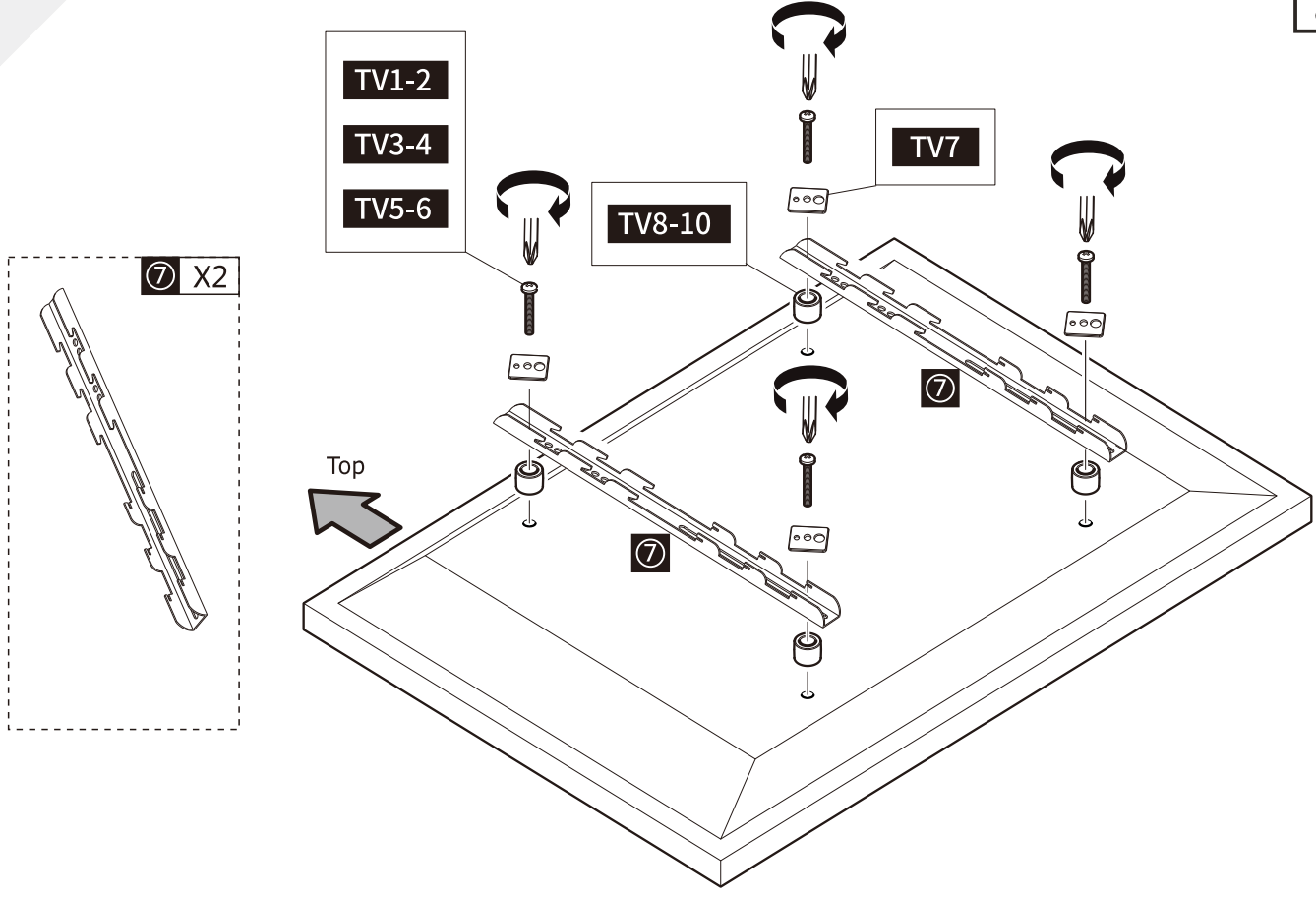

M4
TV1-2 X4

M6
TV3-4 X4

M8
TV5-6 X4

Unterlegscheibe
TV7 X4

Unterlegscheibe
TV7 X4

Unterlegscheibe
TV7 X4

SP1 - SP3
TV8-10
X8

SP1 - SP3
TV8-10
X8

SP1 - SP3
TV8-10
X8

Attach the bracket to the back of your TV using suitable screw, reducer and spacer combinations.

8

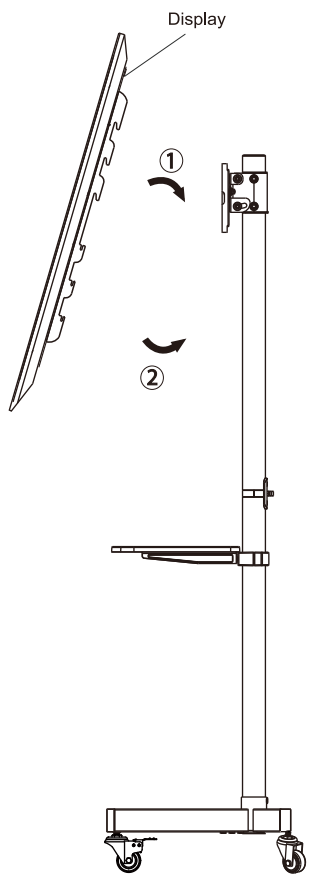

NOT INCLUDED 

